



AD1

Bodypack Transmitter

AD1 Axient Digital Bodypack Transmitter User Guide
Version: 7 (2019-D)

Table of Contents

AD1Bodypack Transmitter	3	Menu Parameter Descriptions	12
WARNING	3	Radio Menu	12
AD1 Axient Digital Bodypack Transmitter	3	Audio Menu	12
Features	3	Utilities Menu	13
Included Components	4	IR Sync	14
Optional Accessories	4	Setting the Frequency Manually	14
AD1 Transmitter Overview	4	Updating Firmware	15
Transmitter Controls	6	Firmware Versioning	15
Locking the Interface	6	Updating the Transmitter	15
Home Screen Display	7	Wearing the Bodypack Transmitter	16
Battery Installation	7	RF Mute	16
Setting the AA Battery Type	8	Safe Start	17
AA Battery Installation	8	Input Overload	18
Shure SB900A Rechargeable Battery	9	Matching Audio Levels with Offset	18
Shure SB900A Runtime	9	Tone Generator	18
Checking Battery Info	9	Specifications	19
Important Tips for Care and Storage of Shure Rechargeable Batteries	10	Input Connector Diagrams	22
AA Batteries and Transmitter Runtime	10	Frequency Bands and Transmitter RF Power	22
Menu Parameters	11	LICENSING INFORMATION	24
Tips for Editing Menu Parameters	11	Australia Warning for Wireless	25
Menu Map	12	Certifications	25
		Information to the user	25

AD1 Bodypack Transmitter

WARNING

- Battery packs may explode or release toxic materials. Risk of fire or burns. Do not open, crush, modify, disassemble, heat above 140°F (60°C), or incinerate.
- Follow instructions from manufacturer
- Only use Shure charger to recharge Shure rechargeable batteries
- **WARNING:** Danger of explosion if battery incorrectly replaced. Replace only with same or equivalent type.
- Never put batteries in mouth. If swallowed, contact your physician or local poison control center
- Do not short circuit; may cause burns or catch fire
- Do not charge or use battery packs other than Shure rechargeable batteries
- Dispose of battery packs properly. Check with local vendor for proper disposal of used battery packs.
- Batteries (battery pack or batteries installed) shall not be exposed to excessive heat such as sunshine, fire or the like

WARNING: Danger of explosion if incorrect battery replaced. Operate only with AA batteries.

Note: Use only with the included power supply or a Shure-approved equivalent.

AD1 Axient Digital Bodypack Transmitter

AD series bodypack transmitters deliver impeccable audio quality and RF performance with wide-tuning, High Density (HD) mode, and encryption. The transmitter features durable metal construction, AA or SB900A rechargeable power (with dockable charging), and TA4 or LEMO3 connector options.

Features

Performance

- 20 Hz to 20 kHz range with flat frequency response
- Automatic input staging optimizes gain setting
- AES 256-bit encryption-enabled for secure transmission
- >120 dB dynamic range
- 100 meter (300 feet) line-of-sight operating range
- Selectable modulation modes optimize performance for spectral efficiency
 - Standard – optimal coverage, low latency
 - High density – dramatic increase in max system channel count
- Built-in tone generator and RF markers to facilitate walk-testing
- Switchable Power Levels = 2/10/35 mW (region dependent)
- Frequency Diversity selection using two bodypacks

Design

- TA4 or LEMO3 audio connector option
- Backlit LCD with easy to navigate menu and controls
- Rugged metal construction
- Flexible $\frac{1}{4}$ wave antenna
- Menu and power lockout

Power

- Over 8 hours continuous use with 2 x AA alkaline batteries
- Shure SB900A lithium-ion rechargeable battery provides extended battery life, precision metering, and zero memory effect
- External charging contacts for docked charging

Included Components

AA alkaline batteries (2)	80B8201
$\frac{1}{4}$ wave antenna	Varies by Region
Threaded TAF4 adapter	WA340
Zipper bag	26A13
Belt clip	44A12547

Optional Accessories

Bodypack rechargeable lithium-ion battery	SB900A
Y-Cable for bodypack transmitters	AXT652
LEMO Y-cable for bodypack transmitters	AXT652LEMO3
Instrument cable	WA302
Replacement belt clip	44A12547
Instrument cable with right angle 1/4" connector	WA304
Mute Switch for Bodypack	WA661
Mute Switch for 2 Bodypacks	WA662

AD1 Transmitter Overview

① RF Antenna

For RF signal transmission.

② Display

View menu screens and settings. Press any control button to activate the backlight.

③ Infrared (IR) Port

Align with the receiver IR port during an IR Sync for automated transmitter tuning and setup.

④ Control Buttons

Use to navigate through parameter menus and to change settings.

⑤ Battery Compartment

Requires two AA batteries or Shure SB900A rechargeable battery.

⑥ AA Battery Adapter

Use to secure AA batteries. Remove when using a Shure SB900A battery.

⑦ SMA Connector

Connection point for RF antenna.

⑧ Power Switch

Powers the unit on or off.

⑨ Power LED

- Green = unit is powered on
- Red = low battery, Mute Mode enabled, input overload, or battery error (see Troubleshooting)

⑩ Input Jack

Connects to a 4-Pin Mini Connector (TA4F) microphone or instrument cable.

Note: A LEMO connector model variation of this transmitter is available.

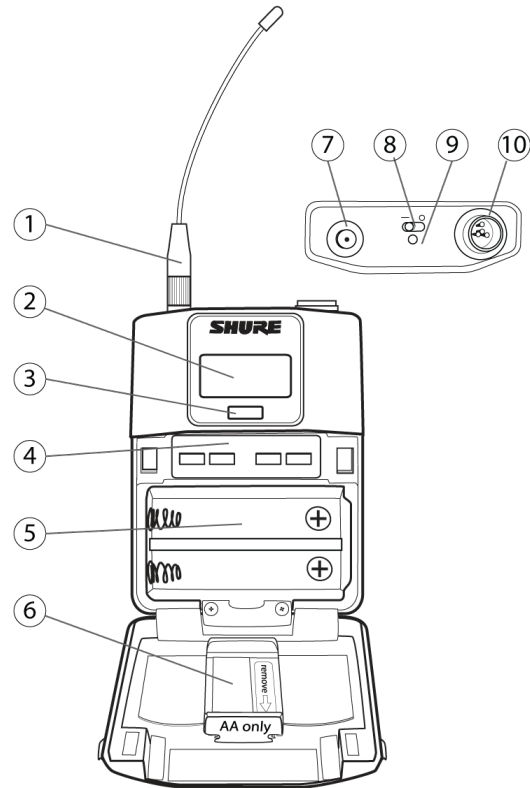

Transmitter Controls

Use the controls to navigate through parameter menus and change values.

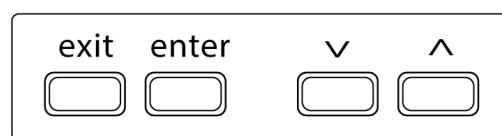

exit	Acts as a 'back' button to return to previous menus or parameters without confirming a value change
enter	Enters menu screens and confirms parameter changes
∧	Use to scroll through menu screens and to change parameter values

Tip: Use the following shortcuts for quick setup:

- Hold the **∧** button while powering on to lock or unlock the transmitter controls.
- Hold the **exit** button while powering on to enter the Safe Start menu.

Locking the Interface

Lock transmitter interface controls to prevent accidental or unauthorized changes to parameters. The lock icon appears on the home screen when the interface lock is enabled.

- From the *Utilities* menu, navigate to *Locks* and select one of the following lock options:
 - None*: The controls are unlocked
 - Power*: The power switch is locked
 - Menu*: The menu parameters are locked
 - All*: The power switch and menu parameters are locked
- Press *enter* to save.

Tip: To quickly unlock a transmitter: Press *enter* twice, select *None*, and press *enter*.





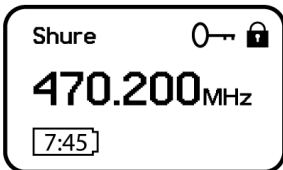

Home Screen Display

The home screen shows transmitter information and status.

There are four pieces of information that you can choose to see on the home screen. Use the arrow buttons to select one of the following choices:

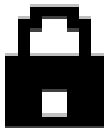
<p>Name Frequency Setting Group (G) and Channel (C) Device ID</p>	
---	---

The following icons indicate transmitter settings:

	<p>Battery runtime in hours and minutes or bar display</p>
	<p>Key: Displayed when encryption is enabled</p>
	<p>Lock: Displayed when controls are locked. Icon will flash if access is attempted to a locked control (power or menu).</p>
	<p>STD: Standard Transmission Mode</p>
	<p>HD: High Density Transmission Mode</p>
	<p>RF Mute Engaged: Displayed when RF output is muted</p>

Battery Installation

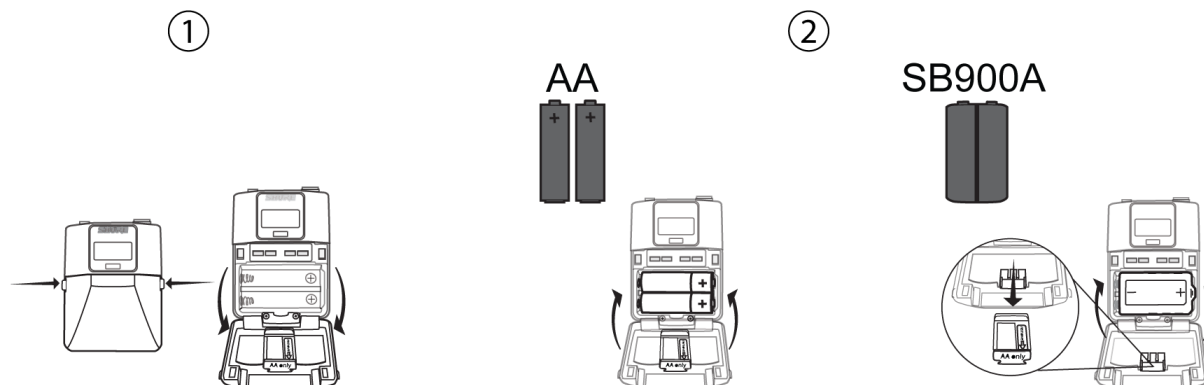

① Accessing the Battery Compartment	Press the side tabs on the bodypack and open the battery door as shown to access the battery compartment.
② Installing Batteries	<ul style="list-style-type: none"> • AA Batteries: Place batteries (note polarity markings) and AA Adaptor as shown and close the door • Shure SB900A Battery: Place battery as shown (note polarity markings). Remove the AA adaptor and set it aside. Close the door to secure the battery. <p><i>Note: If using AA batteries, set the battery type using the transmitter menu.</i></p>

Setting the AA Battery Type

To ensure accurate display of transmitter runtime, set the battery type in the transmitter menu to match the installed AA battery type.

Note: If a Shure SB900A rechargeable battery is installed, selecting a battery type is not necessary and the battery type will display Shure.

1. Navigate to the *Utilities* and select *Battery*.
2. Use the ▼ ▲ buttons to select the installed battery type:
 - *Alkaline* = Alkaline
 - *NiMH* = Nickel Metal Hydride
 - *Lithium* = Lithium Primary
3. Press *enter* to save.

Battery
Battery: Alkaline

Battery
Battery: NiMH

Battery
Battery: Lithium

AA Battery Installation

Fully insert the batteries as shown to ensure proper battery contact and to allow the door to latch securely.

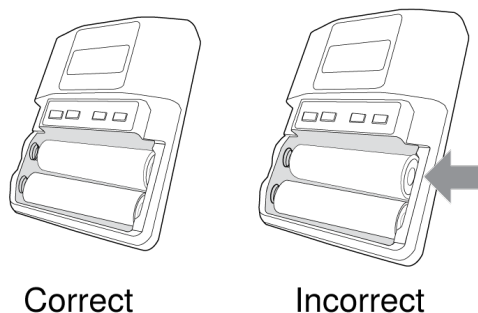

Shure SB900A Rechargeable Battery

Shure SB900A lithium-ion batteries offer a rechargeable option for powering the transmitters. Batteries quickly charge to 50% capacity in one hour and reach full charge within three hours.

Single chargers and multiple bay chargers are available to recharge the Shure batteries.

Caution: Only charge Shure rechargeable batteries with a Shure battery charger.

Shure SB900A Runtime

2 mW	10 mW	35 mW
Up to 9 hours	Up to 9 hours	Up to 5 hours

Checking Battery Info

When using a Shure rechargeable battery, the receiver and transmitter home screens display the number of hours and minutes remaining.

Detailed information for the battery is displayed *Battery* menu of the transmitter: *Utilities > Battery*

- *Battery:* The chemistry type of for the installed battery (Shure, Alkaline, Lithium, NiMH)
- *Bars:* Indicates the number of bars displayed
- *Time:* Battery runtime
- *Charge:* Percentage of charge capacity
- *Health:* Percentage of current battery health
- *Cycle Count:* Total of the number of charging cycles for the installed battery
- *Temperature:* Battery temperature reported in Celsius and Fahrenheit

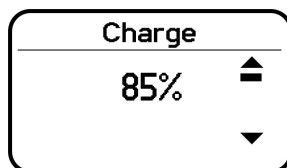

Important Tips for Care and Storage of Shure Rechargeable Batteries

Proper care and storage of Shure batteries results in reliable performance and ensures a long lifetime.

- Always store batteries and transmitters at room temperature
- Ideally, batteries should be charged to approximately 40% of capacity for long-term storage
- Periodically clean the battery contacts with alcohol to maintain ideal contact
- During storage, check batteries every 6 months and recharge to 40% of capacity as needed

For additional rechargeable battery information, visit www.shure.com.

AA Batteries and Transmitter Runtime

Transmitters are compatible with the following AA battery types:







- Alkaline
- Nickel Metal Hydride (NiMH)
- Lithium Primary

A 5-segment battery indicator representing the charge level of the transmitter battery is displayed on the screens of the transmitter and receiver. The following tables contain the approximate remaining transmitter runtime in hours:minutes.



Note: Battery runtimes vary by manufacturer, battery age, and environmental conditions.





AA Batteries and Transmitter Runtime

Alkaline







Battery Indicator	Approximate Runtime Remaining (hours:minutes)
	8:00 - 6:00
	> 4:00
	> 1:45
	≅ 1:45
	≅ 0:45
	≅ 0:15

NiMH (2700 mAh)

Battery Indicator	Approximate Runtime Remaining (hours:minutes)
	11:00 - 8:00
	> 5:00

Battery Indicator	Approximate Runtime Remaining (hours:minutes)
	> 2:00
	≅ 2:00
	≅ 0:45
	≅ 0:15

Lithium Primary (3500 mAh)

Battery Indicator	Approximate Runtime Remaining (hours:minutes)
	14:00 - 10:00
	> 6:00
	> 2:00
	≅ 2:00
	≅ 0:45
	≅ 0:15

Menu Parameters

The *Main* menu organizes the available transmitter parameters into three sub-menus:

- *Radio*
- *Audio*
- *Utilities*

Tip: Use the arrow buttons to scroll between the sub-menus.

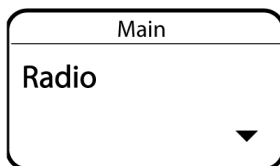

Tips for Editing Menu Parameters

- To access the menu options from the home screen, press the *enter* button. Use the arrow buttons to access additional menus and parameters.
- A menu parameter will blink when editing is enabled
- To increase, decrease or change a parameter, use the arrow buttons

- To save a menu change, press *enter*
- To exit a menu without saving a change, press *exit*

Menu Map

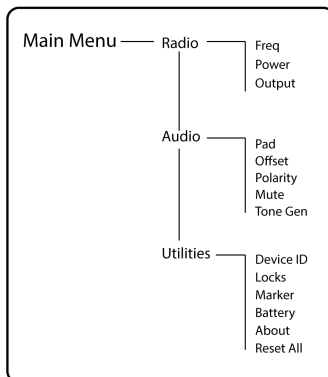

Menu Parameter Descriptions

Radio Menu

Freq

Press the *enter* button to enable editing of a group (G:) channel (C:) or frequency (MHz). Use the arrow buttons to adjust the values. To edit the frequency, press the *enter* button once to edit the first 3 digits, or twice to edit the second 3 digits.

Power

Higher RF power settings can extend the range of the transmitter.

Note: Higher RF power settings decrease battery runtime.

Output

Sets the RF output to On or Mute.

- *On*: RF signal is active
- *Mute*: RF signal is inactive

Audio Menu

Pad

Adjust the pad to avoid overloading the audio input. Select *-12 dB* or *Off*.

Offset

Adjust *Offset* level to balance mic levels when using two transmitters or when assigning multiple transmitters to receiver slots. Adjustment range: *-12 dB* to *+21 dB*.

Polarity

Selectable polarity assignment for the audio input connector:

- *Pos*: Positive pressure on microphone diaphragm produces positive voltage on pin 2 (with respect to pin 3 of XLR output) and the tip of the TRS output.
- *Neg*: Positive pressure on microphone diaphragm produces negative voltage on pin 2 (with respect to pin 3 of XLR output) and the tip of the TRS output.

Mute

When enabled, the power switch is configured as a mute switch for the audio:

- Power switch on: Audio signal on
- Power switch off: Audio signal muted

Exit mute mode to return the power switch to its normal functionality.

Tone Gen

Transmitter will generate a continuous test tone:

- *Freq*: The tone can be set to 400 Hz or 1000 Hz.
- *Level*: Adjusts the output level of the test tone.

Utilities Menu

Device ID

Assign a device ID of up to 9 letters or numbers.

Locks

Locks the transmitter controls and power switch.

- *None*: The controls are unlocked
- *Power*: The power switch is locked
- *Menu*: The menu parameters are locked
- *All*: The power switch and menu parameters are locked

Marker

When enabled, press the enter button to drop a marker in Wireless Workbench.

Battery

Displays battery information:

- *Battery Life*: Runtime reported in bar display and time (hours:minutes)
- *Charge*: Percentage of charge capacity
- *Health*: Percentage of current battery health
- *Cycle Count*: Total of the number of charging cycles for the installed battery
- *Temperature*: Battery temperature reported in Celsius and Fahrenheit

About

Displays the following transmitter information:

- *Model*: Displays the model number
- *Band*: Displays the tuning band of the transmitter

- *FW Version*: Installed firmware
- *HW Version*: Hardware version
- *Serial Num*: Serial number

Reset All

Restores all transmitter parameters to factory settings.

IR Sync

Use IR Sync to form an audio channel between the transmitter and receiver.

Note: The receiver band must match the band of the transmitter.

1. Select a receiver channel.
2. Tune the channel to an available frequency using group scan or manually turn to an open frequency.
3. Power on the transmitter.
4. Press the SYNC button on the receiver.
5. Align the IR windows between the transmitter and the receiver so that the IR LED illuminates red. When complete, *Sync Success!* appears. The transmitter and receiver are now tuned to the same frequency.

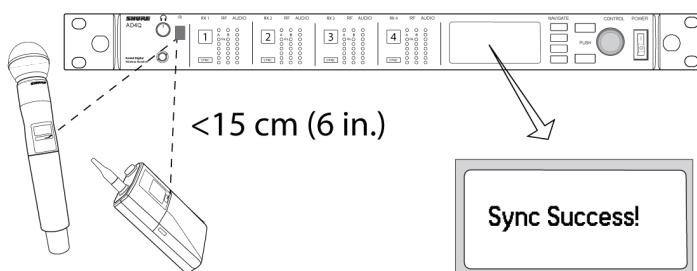

Note:

Any change to the encryption status on the receiver (enabling/disabling encryption) requires a sync to send the settings to the transmitter. New encryption keys for the transmitter and receiver channel are generated on every IR sync, so to request a new key for a transmitter, perform an IR sync with the desired receiver channel.

Setting the Frequency Manually

The transmitter can be manually tuned to a specific group, channel, or frequency.

1. Navigate to the *Radio* menu and select *Freq.*
2. Scroll to select G: and C: to edit the group and channel, or select the frequency parameter (MHz). When editing the frequency, press *enter* once to edit the first 3 digits, or twice to edit the last 3 digits.
3. Use the \wedge \vee buttons to adjust the group, channel, or frequency.
4. Press *enter* to save, and then press *exit* when finished.

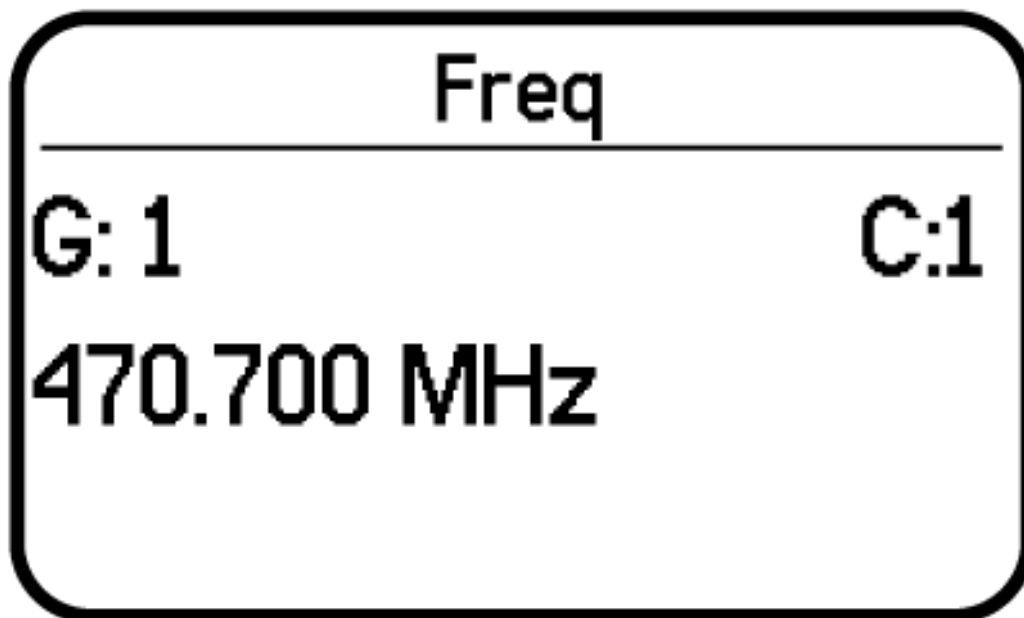

Updating Firmware

Firmware is embedded software in each component that controls functionality. Periodically, new versions of firmware are developed to incorporate additional features and enhancements. To take advantage of design improvements, you can upload and install new versions of the firmware by using the Shure Update Utility. The Shure Update Utility is available for download from <http://www.shure.com/>.

Firmware Versioning

When performing an update, first download firmware to the receiver, and then update transmitters to the same firmware version to ensure consistent operation.

The firmware numbering for Shure devices uses the following format: MAJOR.MINOR.PATCH (e.g., 1.2.14). At a minimum, all devices on the network (including transmitters), must have the same MAJOR and MINOR firmware version numbers (e.g., 1.2.x).

Updating the Transmitter

1. Download the firmware to the receiver.
2. Access the following menu from the receiver: *Device Configuration > Tx Firmware Update*.
3. Align the IR ports between the transmitter and the receiver. IR ports must be aligned for the entire download, which can take 50 seconds or longer.

Tip: The red alignment LED will turn on when the alignment is correct.

4. Press *ENTER* on the receiver to begin the download to the transmitter. The receiver will display the progress of the update as a percentage.

Wearing the Bodypack Transmitter

Clip the transmitter to a belt or slide a guitar strap through the transmitter clip as shown.

For best results, the belt should be pressed against the base of the clip.

Tip: The clip can be removed and rotated 180 degrees to increase mounting options.

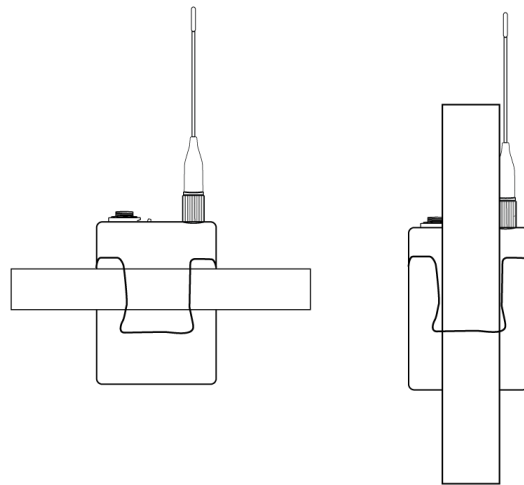

RF Mute

RF Mute prevents transmission of the audio by suppressing the RF signal while allowing the transmitter to remain on. The home screen displays *RF MUTED* in this mode.

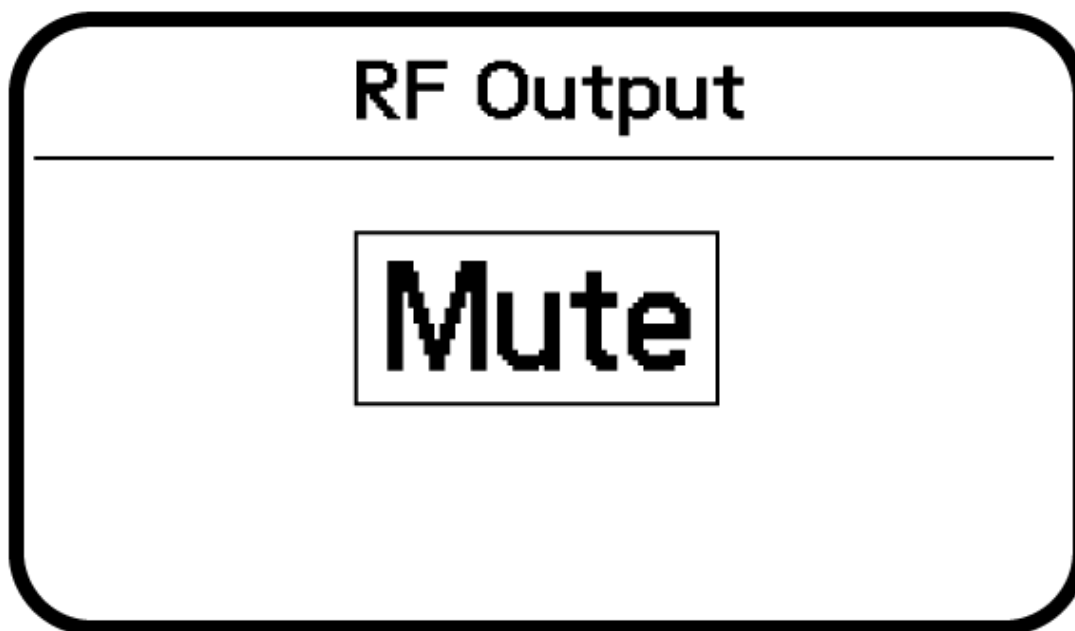

1. From the *Radio* menu, navigate to *Output*.
2. Choose one of the following options:
 - *On*: RF signal is active
 - *Mute*: RF signal is disabled
3. Press *enter* to save.

Turning the transmitter off and on or replacing the battery will restore Output to On.

Safe Start

Power on in Safe Start mode to prevent interference with other devices. Hold the *exit* button while powering on your device until the Safe Start menu appears.

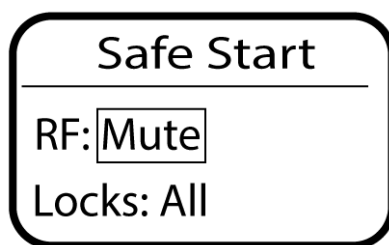

Safe Start menu options:

- *RF: Mute or On*
- *Locks: None, Pwr, Menu, All*

Use the navigation buttons to make changes.

Tip: To exit the Safe Start menu, cycle the power or momentarily remove the battery.

Note: Previous settings for locks and RF will be retained when the transmitter is powered on in Safe Start.

Input Overload

The *OVERLOAD* message appears when the audio input experiences a high-level signal. The power LED turns red as an additional indicator of an overload. Reduce the input signal or enable the input pad to remove the overload condition.

Tip: To enable the input pad, navigate to *Audio > Pad* and select *-12 dB*.



Matching Audio Levels with Offset

When linking two or more transmitters to a receiver, there may be a difference in volume levels between microphones or instruments. If this occurs, use the *Offset* function to match the audio levels and eliminate audible volume differences between transmitters. If using a single transmitter, set *Offset* to 0 dB.

1. Turn on the first transmitter and perform a sound check to test the audio level. Turn off the transmitter when finished.
2. Turn on the second transmitter and perform a sound check to test the audio level. Repeat for any additional transmitters.
3. If there is an audible difference in the sound level between the transmitters, navigate to the *Offset* menu (*Audio > Offset*) in the transmitter to increase or decrease the *Offset* in realtime to match the audio levels.

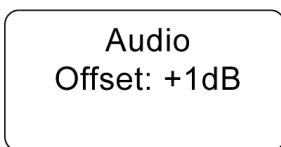

Tone Generator

The transmitter contains an internal tone generator that produces a continuous audio signal. The tone is helpful when conducting a sound check or for troubleshooting the audio signal chain. The level of the tone is adjustable from -60 dB to 0 dB and the frequency can be set to 400 Hz or 1000 Hz.

Tip: Always start with the level set to -60 dB to avoid overloading speakers or headphones.

1. From the *Audio* menu select *Tone Gen*.
2. Set the frequency to *400 Hz* or *1000 Hz*.
3. Select *Level* and use the arrow buttons adjust the value between -60 dB and 0 dB.

Turn off the tone by selecting *Off* from the menu or by cycling the transmitter power.

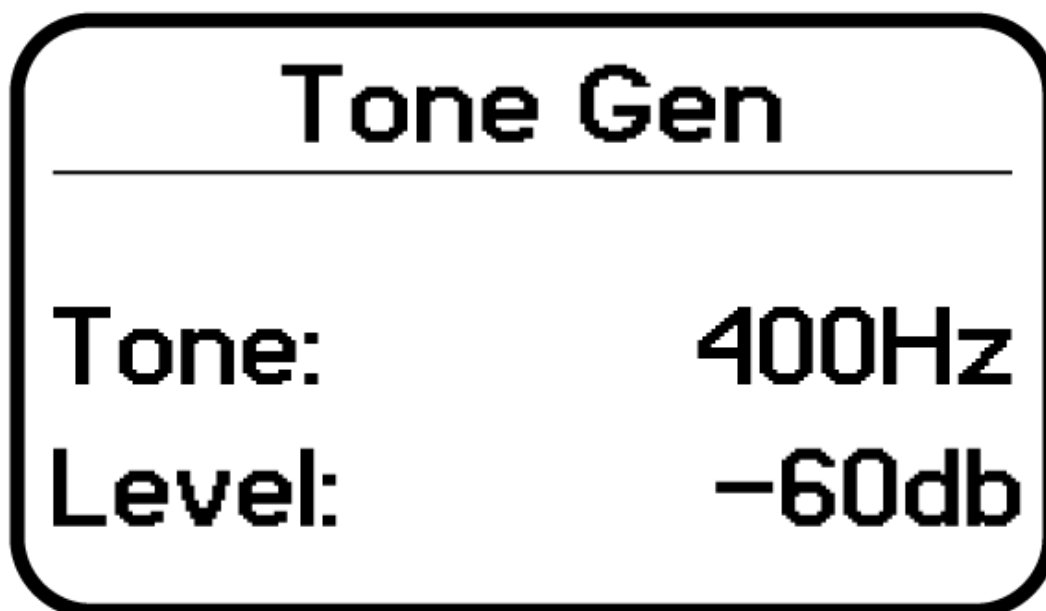

Specifications

Mic Offset Range

-12 to 21 dB (in 1 dB steps)

Battery Type

Shure SB900A Rechargeable Li-Ion or LR6 AA batteries 1.5 V

Battery Runtime

@ 10 mW

Shure SB900A	up to 9 hours
alkaline	up to 8 hours

See Battery Runtime Chart

Dimensions

86 mm x 66 mm x 23 mm (3.4 in. x 2.6 in. x 0.9 in.) H x W x D

Weight

155 g (5.0 oz.), without batteries

Housing

Cast Metal

Operating Temperature Range

-18°C (0°F) to 50°C (122°F)

Note: Battery characteristics may limit this range.

Storage Temperature Range

-29°C (-20°F) to 74°C (165°F)

Note: Battery characteristics may limit this range.

Audio Input

Connector

4-Pin male mini connector (TA4M) or Lemo Connector

Configuration

Unbalanced

Impedance

4-Pin male mini connector (TA4M)	910 k Ω
Lemo Connector	8.2 k Ω

Maximum Input Level

1 kHz at 1% THD

Pad Off	8.5 dBV (7.5 Vpp)
----------------	-------------------

Pad On	20.5 dBV (30 Vpp)
---------------	-------------------

Preamplifier Equivalent Input Noise (EIN)

System Gain Setting $\geq +20$

-120 dBV, A-weighted, typical

RF Output

Connector

SMA

Antenna Type

1/4 wave

Impedance

50 Ω

Occupied Bandwidth

<200 kHz

Channel-to-Channel Spacing

Standard Mode	350 kHz
High Density Mode	125 kHz

varies by region

Modulation Type

Shure Axient Digital Proprietary

Power

2 mW, 10 mW, 35 mW

See Frequency Range and Output Power table, varies by region

Input Connector Diagrams

TA4M

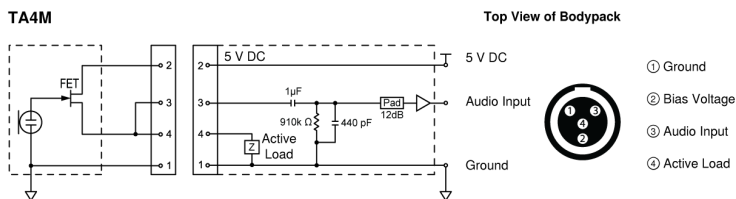

LEMO

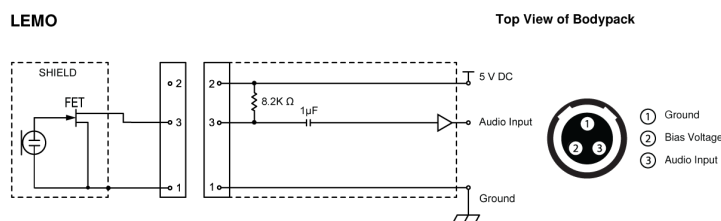

Frequency Bands and Transmitter RF Power

Band	Frequency Range (MHz)	RF Power (mW)***
G53	470 to 510	2/10/35
G54	479 to 565	2/10/20
G55†	470 to 636*	2/10/35
G56	470 to 636	2/10/35
G57	470 to 616*	2/10/35
G62	510 to 530	2/10/35
H54	520 to 636	2/10/35
K53	606 to 698*	2/10/35
K54 Δ	606 to 663**	2/10/35
K55	606 to 694	2/10/35
K56 ◇	606 to 714	2/10/35
K57 Δ	606 to 790	2/10/35
K58	622 to 698	2/10/35

Band	Frequency Range (MHz)	RF Power (mW) ^{***}
L54	630 to 787	2/10/35
R52	794 to 806	10
JB	806 to 810	2/10
X51	925 to 937.5	2/10
X55	941 to 960	2/10/35

*with a gap between 608 to 614 MHz.

**with a gap between 608 to 614 MHz and a gap between 616 to 653 MHz.

***power delivered to the antenna port.

†operation mode varies according to region. In Brazil, High Density mode is used.

△ Output power limited to 10 mW above 608 MHz.

◇Korea defines power as conducted (ERP) which is 1dB less then declared in table.

K55 606-694 MHz

Country Code	Frequency Range
Code de Pays	Gamme de frequences
Codice di paese	Gamme di frequenza
Código de país	Gama de frecuencias
Länder-Kürzel	Frequenzbereich
A, B, BG, CH, CY, CZ, D, DK, EST, F	*
FIN, GB, GR, H, HR, I, IRL, IS, L, LT	*
M, N, NL, P, PL, RO, S, SK, SLO, TR	*
all other countries	*

* This equipment may be capable of operating on some frequencies not authorized in your region. See [Licensing Information](#).

G56 470-636 MHz

Country Code	Frequency Range
Code de Pays	Gamme de frequences
Codice di paese	Gamme di frequenza
Código de país	Gama de frecuencias
Länder-Kürzel	Frequenzbereich
A, B, BG, CH, CY, CZ, D, DK, EST, F	*

Country Code	Frequency Range
Code de Pays	Gamme de frequences
Codice di paese	Gamme di frequenza
Código de país	Gama de frecuencias
Länder-Kürzel	Frequenzbereich
FIN, GB, GR, H, HR, I, IRL, IS, L, LT	*
M, N, NL, P, PL, RO, S, SK, SLO, TR	*
all other countries	*

* This equipment may be capable of operating on some frequencies not authorized in your region. See [Licensing Information](#).

K57 606-790 MHz

Country Code	Frequency Range
Code de Pays	Gamme de frequences
Codice di paese	Gamme di frequenza
Código de país	Gama de frecuencias
Länder-Kürzel	Frequenzbereich
A, B, BG, CH, CY, CZ, D, DK, EST, F	*
FIN, GB, GR, H, HR, I, IRL, IS, L, LT	*
M, N, NL, P, PL, RO, S, SK, SLO, TR	*
all other countries	*

* This equipment may be capable of operating on some frequencies not authorized in your region. See [Licensing Information](#).

LICENSING INFORMATION

Licensing: A ministerial license to operate this equipment may be required in certain areas. Consult your national authority for possible requirements. Changes or modifications not expressly approved by Shure Incorporated could void your authority to operate the equipment. Licensing of Shure wireless microphone equipment is the user's responsibility, and licensability depends on the user's classification and application, and on the selected frequency. Shure strongly urges the user to contact the appropriate telecommunications authority concerning proper licensing, and before choosing and ordering frequencies.

低功率電波輻射性電機管理辦法

第十二條

經型式認證合格之低功率射頻電機，非經許可，公司、商號或使用者均不得擅自變更頻率、加大功率或變更原設計之特性及功能。第十四條

低功率射頻電機之使用不得影響飛航安全及干擾合法通信；經發現有干擾現象時，應立即停用，並改善至無干擾時方得繼續使用。前項合法通信，指依電信法規定作業之無線電通信。低功率射頻電機須忍受合法通信或工業、科學及醫療用電波輻射性電機設備之干擾。

Australia Warning for Wireless

This device operates under an ACMA class licence and must comply with all the conditions of that licence including operating frequencies. Before 31 December 2014, this device will comply if it is operated in the 520-820 MHz frequency band.

WARNING: After 31 December 2014, in order to comply, this device must not be operated in the 694-820 MHz band.

No user-operated control of power, frequency, or other parameters are available beyond those specified in this operating manual.

Please follow your regional recycling scheme for batteries, packaging, and electronic waste.

Certifications

Certified under FCC Part 15 and FCC Part 74.

Certified in Canada to RSS-210.

FCC ID: DD4AD1G55, DD4AD1G57, DD4AD1K53, DD4AD1K54, DD4AD1X55. **IC:** 616A-AD1G55, 616A-AD1K53.

This device complies with Industry Canada licence-exempt RSS standard(s). Operation of this device is subject to the following two conditions: (1) this device may not cause interference, and (2) this device must accept any interference, including interference that may cause undesired operation of the device. Le présent appareil est conforme aux CNR d'Industrie Canada applicables aux appareils radio exempts de licence. L'exploitation est autorisée aux deux conditions suivantes : (1) l'appareil ne doit pas produire de brouillage, et (2) l'utilisateur de l'appareil doit accepter tout brouillage radioélectrique subi, même si le brouillage est susceptible d'en compromettre le fonctionnement.

Meets essential requirements of the following European Directives:

- WEEE Directive 2002/96/EC, as amended by 2008/34/EC
- RoHS Directive 2011/65/EU

Note: Please follow your regional recycling scheme for batteries and electronic waste

This product meets the Essential Requirements of all relevant European directives and is eligible for CE marking.

Hereby, Shure Incorporated declares that the radio equipment is in compliance with Directive 2014/53/EU. The full text of the EU declaration of conformity is available at the following internet address: <http://www.shure.com/europe/compliance>

Authorized European representative:

Shure Europe GmbH

Headquarters Europe, Middle East & Africa

Department: EMEA Approval

Jakob-Dieffenbacher-Str. 12

75031 Eppingen, Germany

Phone: +49-7262-92 49 0

Fax: +49-7262-92 49 11 4

Email: EMEAsupport@shure.de

Information to the user

This device complies with part 15 of the FCC Rules. Operation is subject to the following two conditions:

1. This device may not cause harmful interference.
2. This device must accept any interference received, including interference that may cause undesired operation.

These limits are designed to provide reasonable protection against harmful interference in a residential installation. This equipment generates uses and can radiate radio frequency energy and, if not installed and used in accordance with the instructions, may cause harmful interference to radio communications. However, there is no guarantee that interference will not occur in a particular installation. If this equipment does cause harmful interference to radio or television reception, which can be determined by turning the equipment off and on, the user is encouraged to try to correct the interference by one or more of the following measures:

- Reorient or relocate the receiving antenna.
- Increase the separation between the equipment and the receiver.
- Connect the equipment to an outlet on a circuit different from that to which the receiver is connected.
- Consult the dealer or an experienced radio/TV technician for help.

Canada Warning for Wireless

This device operates on a no-protection, no-interference basis. Should the user seek to obtain protection from other radio services operating in the same TV bands, a radio licence is required. For further details, consult Innovation, Science and Economic Development Canada's document Client Procedures Circular CPC-2-1-28, Voluntary Licensing of Licence-Exempt Low-Power Radio Apparatus in the TV Bands.

Ce dispositif fonctionne selon un régime de non-brouillage et de non-protection. Si l'utilisateur devait chercher à obtenir une certaine protection contre d'autres services radio fonctionnant dans les mêmes bandes de télévision, une licence radio serait requise. Pour en savoir plus, veuillez consulter la Circulaire des procédures concernant les clients CPC.2.1.28, Délivrance de licences sur une base volontaire pour les appareils radio de faible puissance exempts de licence et exploités dans les bandes de télévision d'Innovation, Sciences et Développement économique Canada.

This device operates on frequencies shared with other devices. Consult the Federal Communications Commission White Space Database Administration website to determine available channels in your area prior to operation.

This device contains licence-exempt transmitter(s)/receiver(s) that comply with Innovation, Science and Economic Development Canada's licence-exempt RSS(s). Operation is subject to the following two conditions:

1. This device may not cause interference.
2. This device must accept any interference, including interference that may cause undesired operation of the device.

L'émetteur/récepteur exempt de licence contenu dans le présent appareil est conforme aux CNR d'Innovation, Sciences et Développement économique Canada applicables aux appareils radio exempts de licence. L'exploitation est autorisée aux deux conditions suivantes :

1. L'appareil ne doit pas produire de brouillage;
2. L'appareil doit accepter tout brouillage radioélectrique subi, même si le brouillage est susceptible d'en compromettre le fonctionnement.